

Safety & Installation Instructions

v1.2 -04.19

These instructions are provided for your safety in order to prevent the risk of Fire, Electric shock or Injury. It is vitally important that they are read in their entirety before installing your fitting. Please retain for future reference.

1. If you are in any doubt consult a qualified electrician as to the installation of the fitting. Install in accordance with current IEE wiring regulations. It is recommended that this fitting is installed by a qualified electrician.
2. Ensure that the electrical supply is OFF. Disconnect the electrical supply at the fuse-board.
3. If removing an existing fitting first, note all wiring connections: record which of the house wires is connected to the live, neutral and earth terminals.
4. Carefully identify where the supply cable is (and check there are no other cables in the area) to avoid damage to concealed wiring during installation.
5. Position the light where desired ensuring that there is suitable support adjacent to where you will connect to the house supply and mark position of fixing holes, before drilling appropriate holes as below.
6.
 - a. Brick or masonry: Drill holes into which the wall plugs tightly fit, then insert wall plugs.
 - b. Wood: No hole necessary (unless small pilot hole required), screws can be screwed directly into the timber.
 - c. Plaster/Cavity: Special cavity wall fittings are required, rather than provided fixings. These are widely available from good hardware or DIY store and should come with their own instructions that must be followed. It may be easier to relocate the fitting so that you screw directly into a timber joist or beam.
7. Once desired drop determined, adjust the flex length accordingly. Consult an electrician if in any doubt.
 - Use wire cutters to cut flex at desired length and then remove 30mm of the outer sleeve & braid (making sure no damage occurs to the interior cables). Apply electrical insulation tape over the ends of the braid to prevent fraying.
 - Remove 10mm of insulation from the conductors, ready to be wired into a connector block.
8. Support the fitting so that no strain is applied to the wiring when making the electrical connections. If necessary get a colleague to help.
9. Electrical connection: this light fitting is double insulated, DO NOT connect to an Earth wire or terminal. Make connections using the connector block, following the diagram below. A small flat-head screwdriver is required.

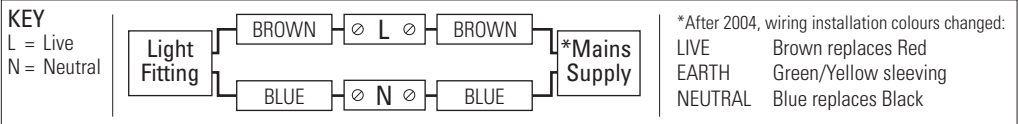

10. Double check all the connections are secure and that no loose strands of wire are left out of the connector, then firmly close the lid of the connector block.
11. Check that no wires are trapped behind or within the fitting and complete the installation, see hanging instructions inside.
12. Fit the correct type and wattage of lamp (or less). Be careful not to overtighten the lamp.
13. Switch on at the fuse-board. Your light fitting is now ready for use.

Other Important Information

Switch off at mains before changing lamp(s). Never fit a lamp of greater wattage than recommended. Ensure children do not play with the light fitting. Dispose of old lamps carefully. Never leave a fitting without a lamp in position (or someone can accidentally touch the contacts). Adjust fitting only when power to the fitting is off and has been left to cool. If the electrical flex or electrical components become damaged at any point, power to the fitting should be disconnected immediately and not operated until the damaged parts are fixed/replaced. For use in a dry, indoor environment only. Ensure the fitting does not come into contact with any liquids.

Cleaning and Maintenance

Metal finishes should only be cleaned with a soft, dry cloth. Do not use polishes or abrasives. Switch off power to the fitting before cleaning.

Established in 1990, Original BTC manufactures relaxed, familiar lighting for traditional and contemporary homes. All products are hand-assembled in Oxford from high quality components, produced in the UK.

ORIGINALBTC.COM
 +44 (0)1993 882 251
 UNIT 21 / 22 AVENUE ONE, STATION LANE, WITNEY, OX28 4XZ, ENGLAND



Giant Pendant Lights

Instruction Manual

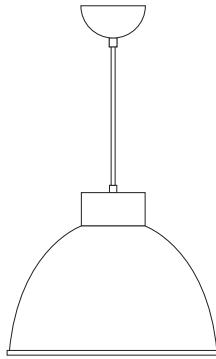

Giant Size 0 Pendant Light, FP233

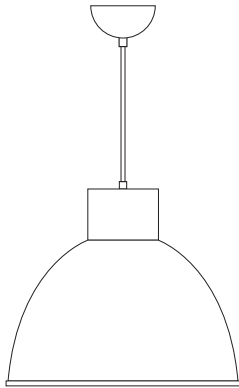

Giant Size 1 Pendant Light, FP066

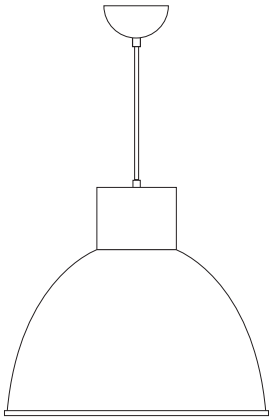

Giant Size 2 Pendant Light, FP065

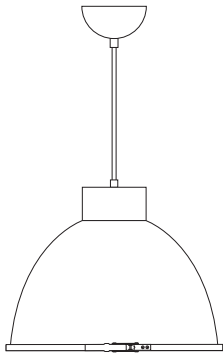

Giant 0 Pendant Light with Wired Glass- FP233/GL00W

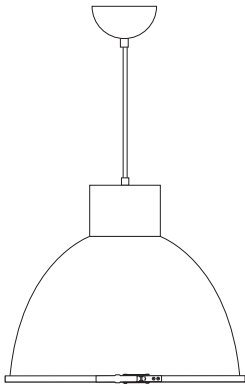

Giant 1 Pendant Light with Wired Glass- FP066/GL01W

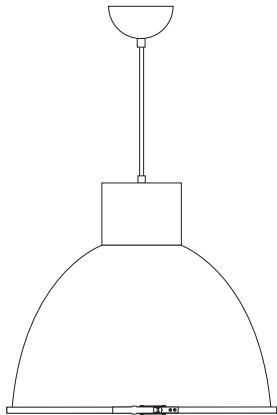

Giant 2 Pendant Light with Wired Glass- FP065/GL02W

ORIGINAL BTC
 BRITISH LIGHTING MANUFACTURERS
 LONDON - NEW YORK - PARIS









Giant Pendant Lights

| 230V ac 50Hz | IP20

FP233	Giant Size 0	FP233/GL00W	Giant Size 0 With Wired Glass
FP066	Giant Size 1	FP066/GL01W	Giant Size 1 With Wired Glass
FP065	Giant Size 2	FP065/GL02W	Giant Size 2 With Wired Glass

Inspired by traditional factory fittings, metal pendant shades bring a clean-lined, industrial style. Lightly polished, reflective Giants are fitted with 'Tinned' braided cable and can be grouped together for added impact.

LAMP GUIDANCE Giant Pendants					
BASE	SHAPE	TYPE*	WATTAGE**		
			FP233, FP066, FP065, FP065/GL	FP233/GL	FP066/GL
 E27  GLS  BALL	 INCANDESCENT ✓  CFL ✓  ECO-HALOGEN ✓  LED ✓	100W MAX	40W MAX	60W MAX	
		20W	11W	15W	
		70W	28W	42W	
		18W	7W	12W	

* Warm white (2700k) low energy lamps recommended.
 ** Wattage value provided as a guide to suitable lamps. Lower wattage than stated may be used.

Visor Instructions

A wired glass visor can be supplied with the fitting. Prior to installation, this should be removed:

- Remove tab (a) from clip (d).
- Whilst supporting the glass (c) with one hand, undo clip to remove glass.

Install fitting as described on opposite & reverse pages, then fit visor to fitting:

- Hold the glass in place against the opening of the reflector (b),
- Close the clip to close the visor band (e) around the rim of the reflector and the underside of the glass, so the visor band supports the glass. Make sure the band secures only around the rim as it could mark the shade if lined up incorrectly.
- Insert tab into clip, bending top and bottom around clip to hold visor band securely to the reflector.

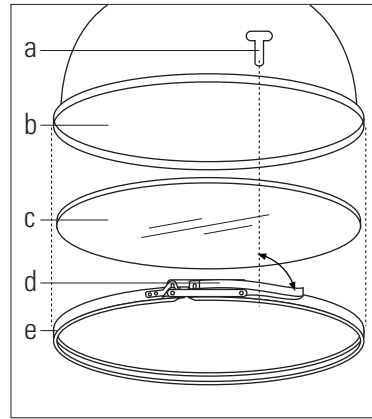

Installation Diagram

Contents

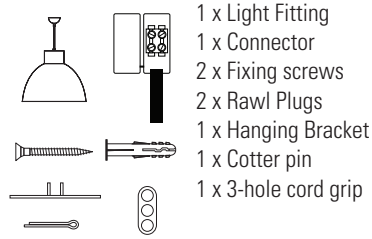

Tools Required

- Cross head screwdriver
- Small flat-head screwdriver
- Drill (if holes are required)

Key

- A Rawl plugs
- B Main supply
- C Fixing screws
- D Hanging bracket
- E Cotter pin
- F 3-hole cord grip
- G Insulated connector block
- H Ceiling rose
- I Cord grip
- J Luminaire flex

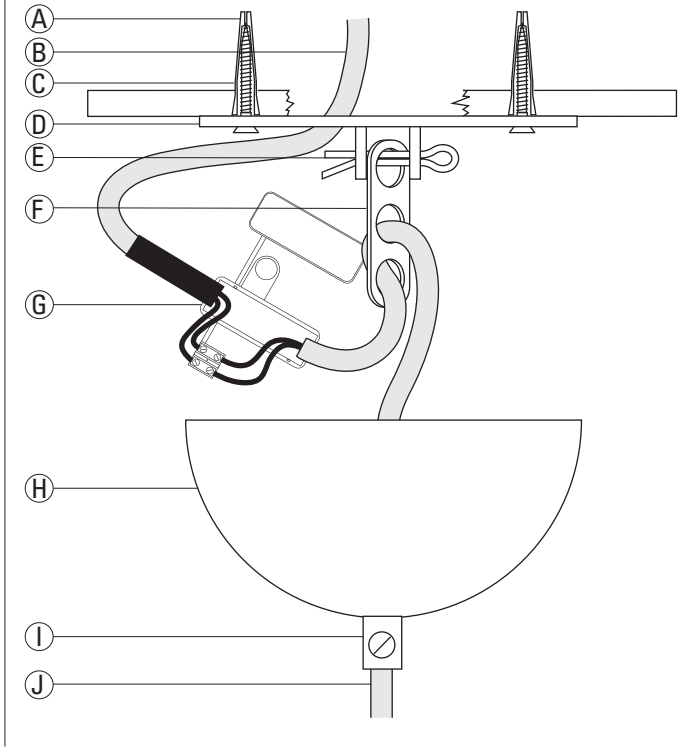

PLEASE READ THE INSTRUCTIONS ON THE REVERSE BEFORE YOU BEGIN INSTALLING YOUR LIGHT

Hanging Instructions

- Screw the hanging bracket (D) to the ceiling using the rawl plugs and screws as necessary.
- Place the cotter pin (E) through the first hole in the hanging bracket (D), then through the top hole of the 3-hole cord grip (F), before inserting through second hole in hanging bracket. Bend one 'leg' of pin (E) back using pliers to prevent pin sliding out of the bracket.
- Determine the required drop of the fitting and adjust flex (J) length as necessary- see point 7 overleaf.
- Before wiring, ensure the luminaire flex (J) is threaded through the middle hole of the cord grip (F) and out of the bottom hole as shown in the diagram to ensure the pendant hangs straight.
- Make connection to the mains supply (follow instructions over leaf), using the insulated connector block (G) provided, ensuring the mains supply is inserted through the black tube on one side of the connector first. Once connection is made, close the lid of the connector block firmly, so that it locks together securely.
- The ceiling rose can now be pushed up over the bracket and the connection: Loosen the screw on the cord grip (I) before pushing the ceiling rose up so that it sits flush against the ceiling, then tighten the grub screw to hold the ceiling rose in position. Do not overtighten grub screw.