

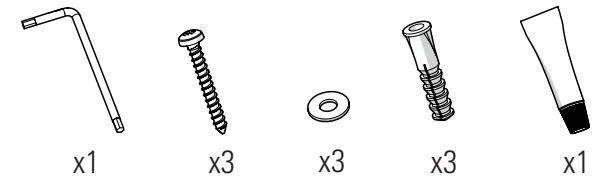

Class 1
 E27

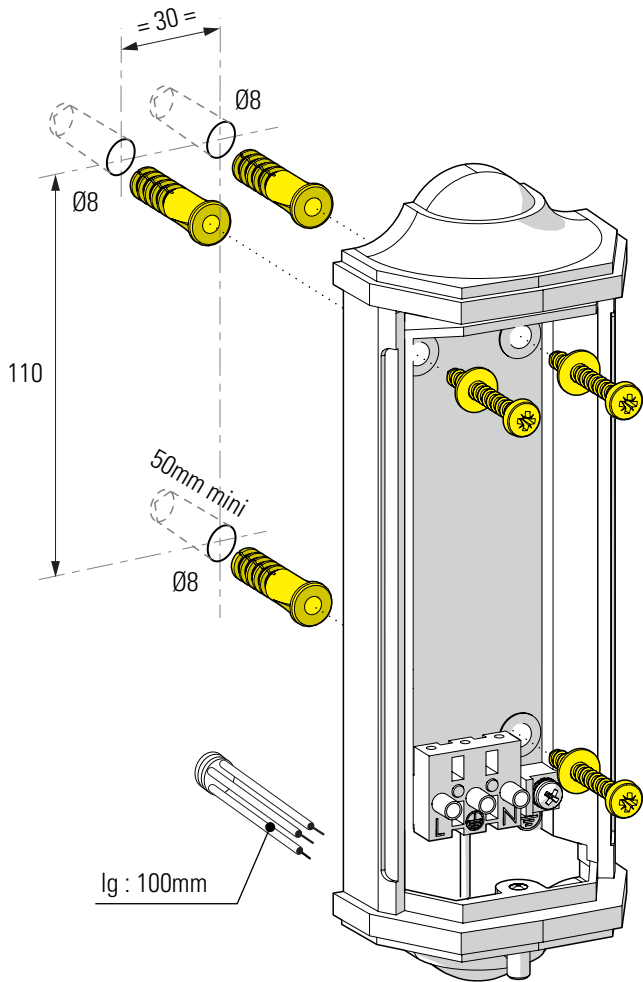

1 Fixation murale Fix to the wall



2 Raccordement électrique Connect electrical wires

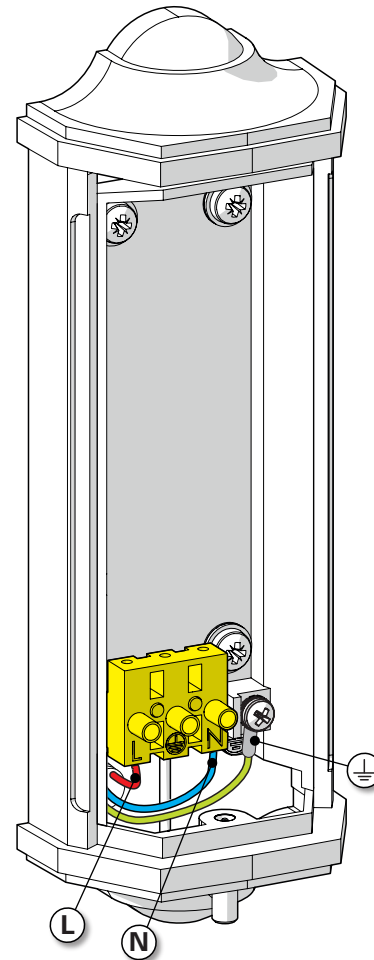

3 Montage de la lampe & du globe Install the light-bulb & the globe

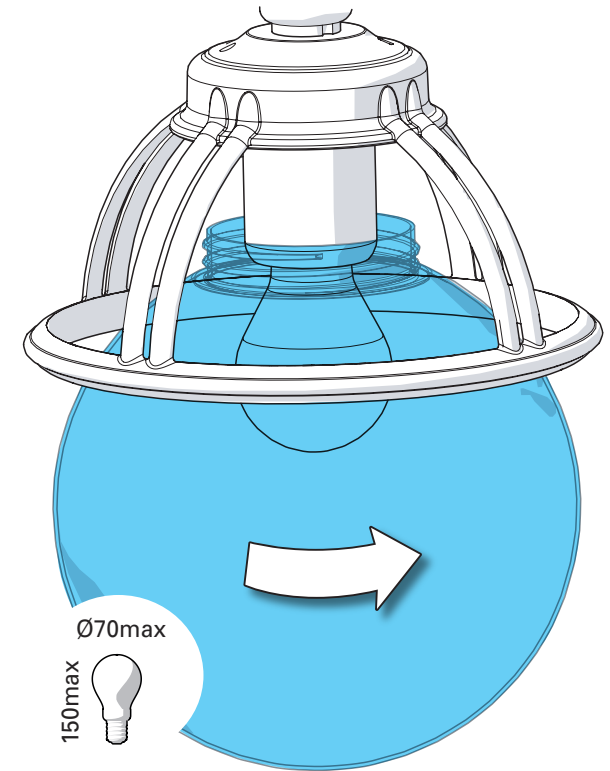

5 Raccordement électrique
Connect electrical wires

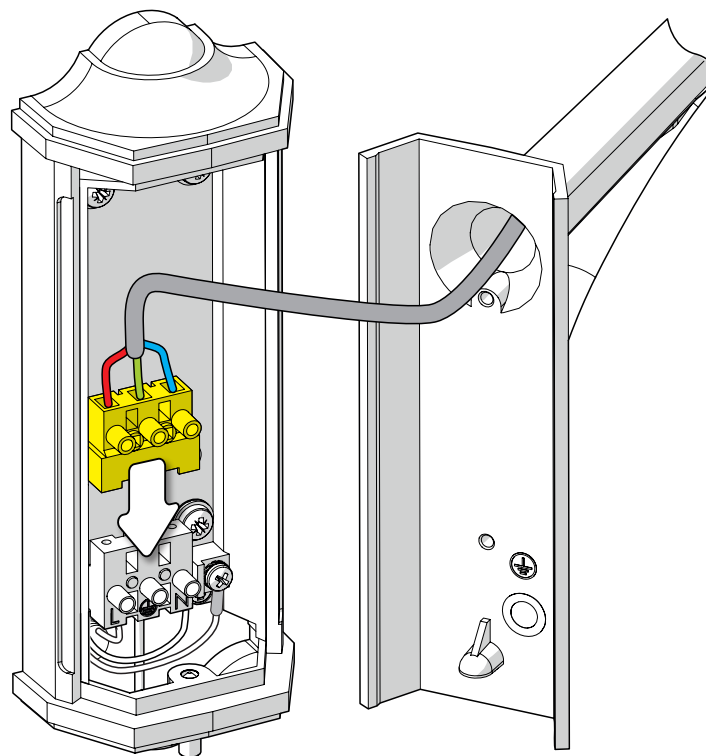

6 Fixation du luminaire
Fix the luminaire

