

a

by arturo alvarez

virginia collection

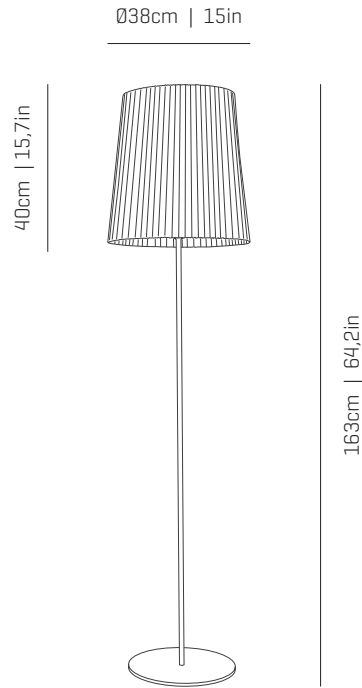

ref. VG03A



VG03A VG03B VG04A VG04B

MATERIALS & COMPONENTS | MATERIALES & COMPONENTES

LAMP SHADE | TULIPA

Painted stainless steel | One color to choose
Acero inoxidable pintado | Un color a elegir

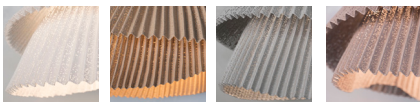

BL BE G T

CUSTOM
COLOR

Stainless steel
Acero inoxidable

SUPPORT AND CABLE

SOPORTE Y CABLE

Stainless steel
Acero inoxidable

Transparent cable
Cable transparente

Standard: 250cm | 98,4in

RECOMMENDED BULBS

BOMBILLAS RECOMENDADAS

230V - 50Hz

- E27 LED Vintage - Max. 1x12 W
- E27 LED Standard - Max. 1x12 W

120V - 60Hz

- E26 LED - Max. 1x12 W

ENERGY EFFICIENCY

EFICIENCIA ENERGÉTICA

from A++ to E
desde A++ a E

OTHER DATA | OTROS DATOS

NET WEIGHT

PESO NETO

10,5kg | 23,1lb

PACKAGING

EMBALAJE

155x11x11cm | 61x 4,3x 4,3in
44x44x50cm | 17,3x 17,3x 19,7in
12kg | 26,5lb

ELECTRICAL FEATURES

CARACTERÍSTICAS ELÉCTRICAS



CERTIFICATIONS

CERTIFICACIONES



a

by arturo alvarez

ASSEMBLY INSTRUCTIONS
INSTRUCCIONES DE MONTAJE

Virginia

ref. VG03A

Suitable for indoor use, at 25°C

Apta para uso interior a temperatura ambiente de 25°C

Box contains | Contenido de la caja:

A - Lampshade | Tulipa [1]

B - Pie | Foot/support [1]

C - Base | Base [1]

D - Fixing washer | Arandela de fijación [1]

E - Screw | Tornillo [1]

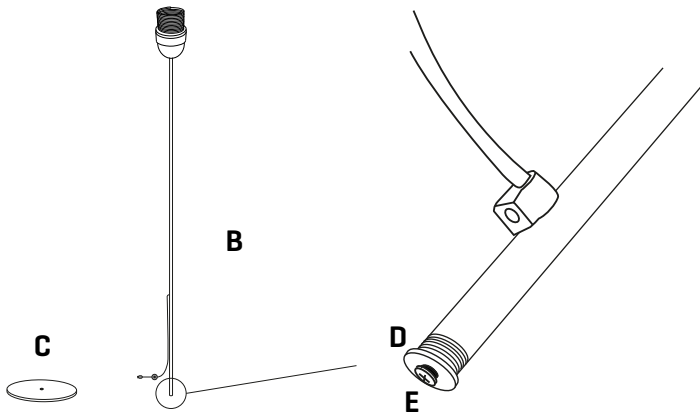
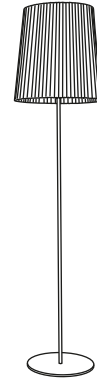

1

The foot is shipped separately from its base, unpack both to proceed with its assembly. First take the foot and unscrew the screw and the washer, set them aside for the third step.

El pie se envía separada de la base, desembale ambos para proceder a su montaje. Primero coja la el pie y desenrosque el tornillo y la arandela, apártelas para el tercer paso.

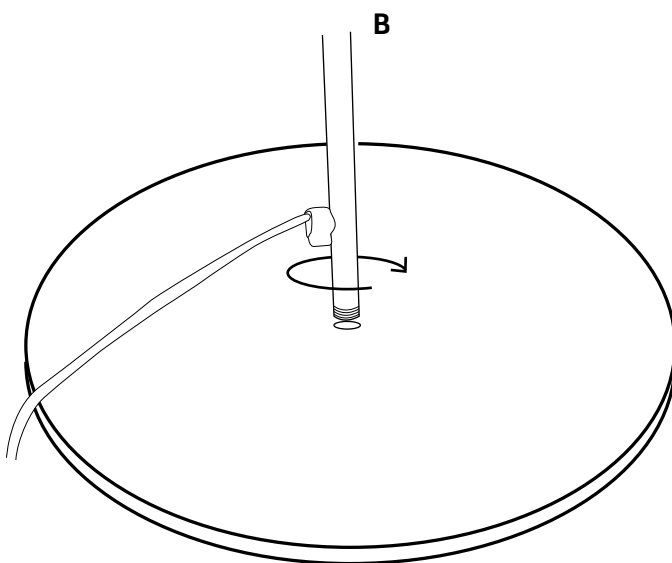

2

IMPORTANT! Carry out this step carefully, the lampshade is delicate.

Screw the tulip tube to the base in an upright position, it should be inserted approximately one centimeter.

¡IMPORTANTE! Realice este paso con cuidado, la tulipa es delicada. Enrosque el tubo de la tulipa a la base en posición vertical, debe introducirse aproximadamente un centímetro.

a

by arturo alvarez

ASSEMBLY INSTRUCTIONS
INSTRUCCIONES DE MONTAJE

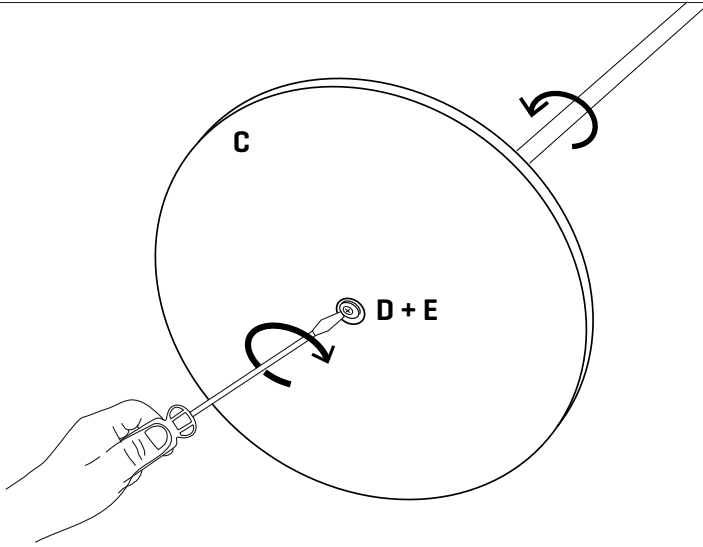

3

Take the screw and washer that you removed in step 1 and thread it into the tube. Hold the tube and readjust to tighten so the assembly secure.

Vuelva a coger el tornillo y la arandela que quitó en el paso 1 y enrósquela en el interior del tubo. Sujete el tubo y reajuste al apriete para que el conjunto quede seguro.

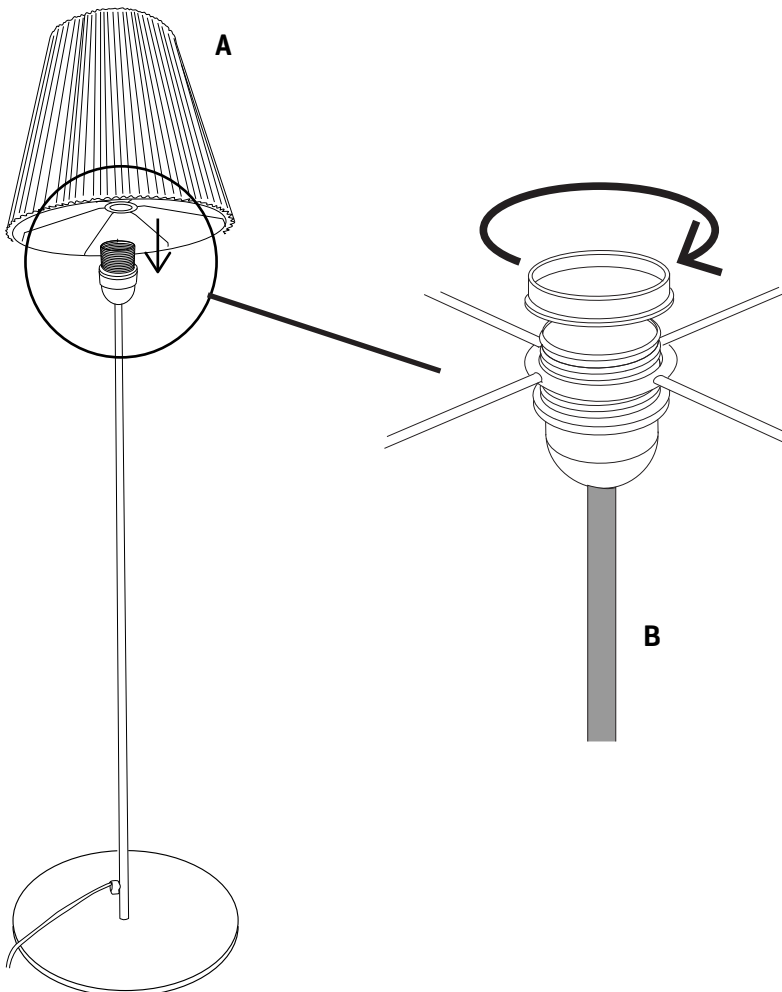

4

Introduce the diffuser over the socket and join all together with the fixing nut.

Sobre el portalámparas coloque la tulipa y apriete ambos con la rosca.