

# Safety & Installation Instructions

These instructions are provided for your safety in order to prevent the risk of Fire, Electric shock or Injury. It is vitally important that they are read in their entirety before installing your fitting. Please retain for future reference.

1. If you are in any doubt consult a qualified electrician as to the installation of the fitting. Install in accordance with current IEE wiring regulations. It is recommended that this fitting is installed by a qualified electrician.
2. Ensure that the electrical supply is OFF. Disconnect the electrical supply at the fuse-board.
3. If removing an existing fitting first, note all wiring connections: record which of the house wires is connected to the live, neutral and earth terminals.
4. Carefully identify where the supply cable is (and check there are no other cables in the area) to avoid damage to concealed wiring during installation.
5. Position the light where desired ensuring that there is suitable support adjacent to where you will connect to the house supply and mark position of fixing holes, before drilling appropriate holes as below.
6.
  - a. Brick or masonry: Drill holes into which the wall plugs tightly fit, then insert wall plugs.
  - b. Wood: No hole necessary (unless small pilot hole required), screws can be screwed directly into the timber.
  - c. Plaster/Cavity: Special cavity wall fittings are required, rather than provided fixings. These are widely available from good hardware or DIY store and should come with their own instructions that must be followed. It may be easier to relocate the fitting so that you screw directly into a timber joist or beam.
7. Support the fitting so that no strain is applied to the wiring when making the electrical connections. If necessary get a colleague to help.
8. Electrical connection: this light fitting must be earthed. Make connections following the diagram below. A small flat-head screwdriver is required.

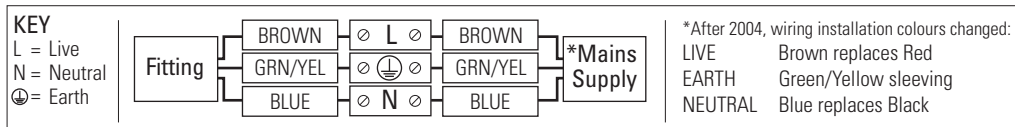

9. Double check all the connections are secure and that no loose strands of wire are left out of the connector, Use a good quality electrical insulation tape to cover the connector blocks and at least 25mm of the cables going in to either end of the connectors.
10. Check that no wires are trapped behind or within the fitting and complete the installation, referring to the Installation diagram inside.
11. Fit the correct type and wattage of lamp (or less). Be careful not to overtighten the lamp.
12. Switch on at the fuse-board. Your light fitting is now ready for use.

## Other Important Information

Switch off at mains before changing lamp(s). Never fit a lamp of greater wattage than recommended. Ensure children do not play with the light fitting. Dispose of old lamps carefully. Never leave a fitting without a lamp in position (or someone can accidentally touch the contacts). Adjust fitting only when power to the fitting is off and has been left to cool. If the electrical flex or electrical components become damaged at any point, power to the fitting should be disconnected immediately and not operated until the damaged parts are fixed/replaced. For use in a dry, indoor environment only. Ensure the fitting does not come into contact with any liquids.

## Cleaning and Maintenance

Metal finishes should only be cleaned with a soft, dry cloth. Do not use polishes or abrasives. Bone china can be cleaned by hand, using a soft damp cloth with a diluted mild detergent (nonabrasive) if necessary. Switch off power to the fitting before cleaning.

Established in 1990, Original BTC manufactures relaxed, familiar lighting for traditional and contemporary homes. All products are hand-assembled in Oxford from high quality components, produced in the UK.

ORIGINALBTC.COM  
+44 (0)1993 882 251  
UNIT 21 / 22 AVENUE ONE, STATION LANE, WITNEY, OX28 4XZ, ENGLAND



# Chester Wall Light

## Instruction Manual

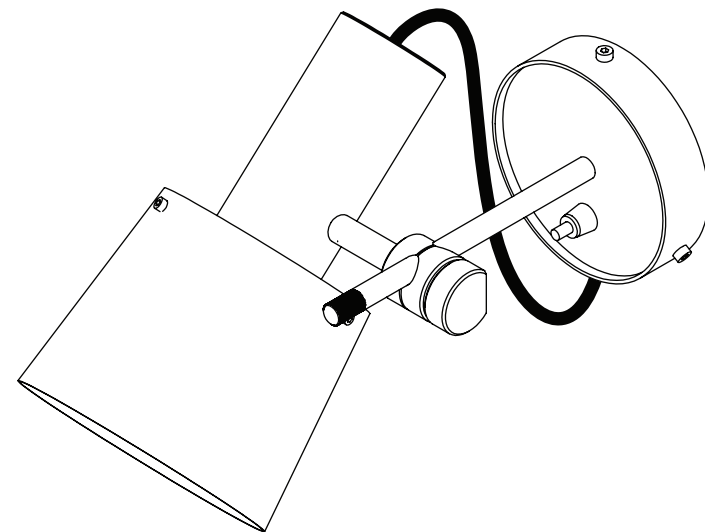





**ORIGINAL BTC**  
BRITISH LIGHTING MANUFACTURERS  
LONDON - NEW YORK - PARIS



# Chester Wall Light

| 230V ac 50Hz | IP20 |

FW582 Chester Wall Light

LAMP GUIDANCE			
BASE	SHAPE	TYPE*	WATTAGE**
		INCANDESCENT ✓	40W MAX
		CFL ✓	15W
		ECO-HALOGEN ✗	n/a
		LED ✓	10W

\* Warm white (2700k) low energy lamps recommended.  
 \*\* Wattage value provided as a guide to suitable lamps. Lower wattage than stated may be used.

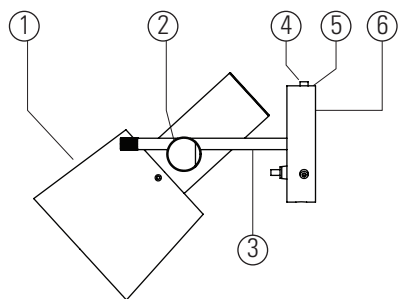

Fixing Pack

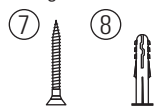

## Contents

- 1 - Head
- 2 - Clamp
- 3 - Stem
- 4 - Cap Screw
- 5 - Back box
- 6 - Wall bracket
- 7 - 2 x fixing screws
- 8 - 2 x rawl plugs

## Required for Installation

- Screwdriver, flat-head
- Hex Key size 3
- Small screwdriver, flat-head
- Drill (if holes are required)

PLEASE READ THE INSTRUCTIONS ON THE REVERSE BEFORE YOU BEGIN INSTALLING YOUR LIGHT

## Installation and Assembly Instructions

Refer to diagrams on opposite page.

### STEP 1

Remove the wall bracket from the back box by undoing the three cap head screws using a hex key

### STEP 2

Mark fixing holes through fixing bracket before drilling holes, see point 5 on reverse. Ensure holes will result in the backplate being straight, then screw fixing bracket to the wall, ensuring fitting is securely fixed to the wall.

### STEP 3

Make electrical connection to mains supply, see points 7 to 10 on reverse page.

### STEP 4

Slide the backbox over the wall bracket, aligning the three holes around the circumference. Secure in place using the three cap head hex screws

## Installation Diagram

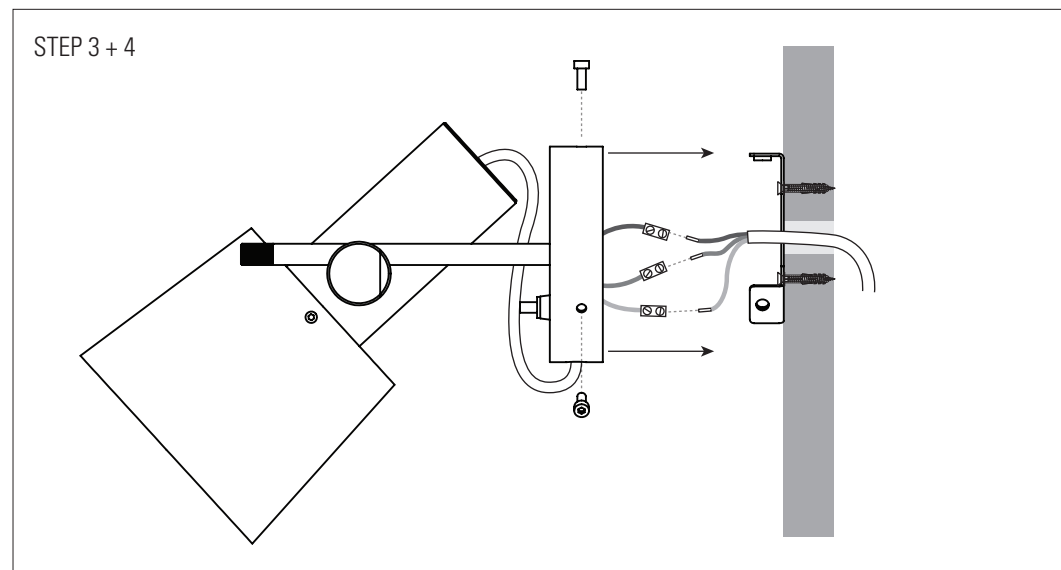
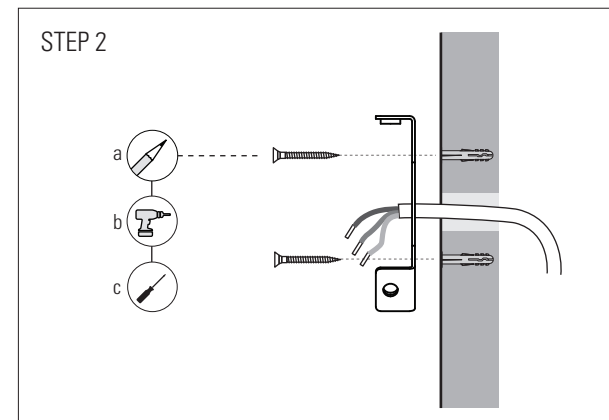
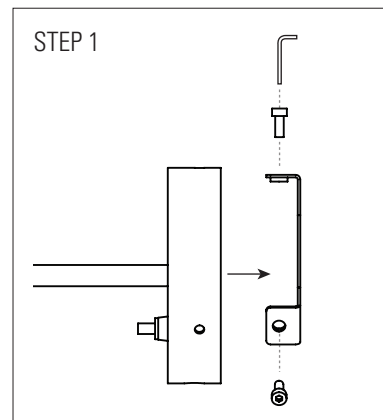

## Adjusting the fitting

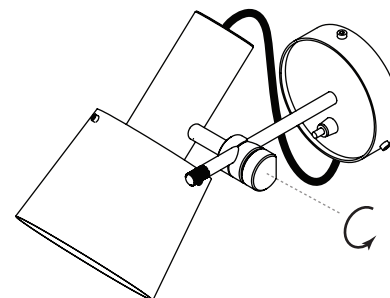

Loosen the clamp before moving or swiveling the head, and retighten in the desired position